

Dual-waveband Fusion Rifle scope

AIM 1C



Catalogue

Project	Content	Page
	Cover	1
	Catalogue	2
	Revising History	2
1	Product Overview	3
2	Product Applications	3
3	Product Parameters	4
4	Product Illustration	5-6
5	Product Usage	6-7
6	Menu Interface	7-9
7	Operation Instruction	9-10
8	Precautions	10-11
9	Package and Accessories	11

Revisions History

Versions	Revisions History	Comment
1.0	First Edition	2023.6.6

1. Product Overview

Dual-waveband Fusion Telescope scope is an electronic device used for observing targets, equipped with low-light/thermal imaging cameras. The fused image can not only quickly find the target in an extremely low-light environment, but also clearly see the details of the target and the surrounding environment. The product has laser ranging function. The viewfinder is bright and big, clear and comfortable. It can be used to quickly searching, locating, and confirming targets.

The product is light, compact, durable, and can meet the requirements of high-strength impact vibration. It is suitable for various scenarios such as military and civil safety supervision.



2. Product Features

- Multi-camera fusion with high Image quality.
- Large and bright eyepiece for comfortable observation.
- Continuous laser ranging function.
- Features target highlighting function.
- Convenient and efficient operation through scroll wheels, shortcut buttons, and attitude control.
- Unnecessary to fill extra light at night to avoid expose yourself.

3. Product Parameters

Product Name		AIM 1C
Dual-Camera		Low-light + Thermal
Imaging Sensor	Resolution	1920×1200 / 384 × 288
	Video Color	False Color
	Frame Rate	25fps
Optics	Objective Lens	98mm F1.45 + 25mm F1.4
	Field of View	11.2°× 8.4°
	Focusing Mode	Manual rotation
	Magnification Factor	3.6×
	Digital Zoom	1×、 2×、 4x
Viewfinder		2.1 inch, 1600×1200
Detection Performance	Detect Hog Target	>800yards, target on hog size
Video Recording	Local Storage	128G (About 30 h)
	Resolution	1920×1200 @ 25fps
Other Features	Electronic Compass	Indicates direction and angle of pitch
	Positioning	GPS, BDS
Interface	2.4G WiFi	Mobile APP can display and storage, 1920×1200 @ 25fps
	HDMI	1920×1080 @ 60fps
	USB Type C	Local video & photo copying, power charging
Operational Characteristics	Battery Life	2 × 18650 batteries, ≥7 h
	Operating Temperature	-30°C~+50°C
	Storage Temperature	-45°C~+70°C
	Ingress Protection	IP65
	Size	274.4mm×76mm×116mm (with eyepiece cover) , 229mm×76mm×116mm (without eyepiece cover)
	Weight	2pounds6ounces (with batteries and mount)

4.Product Illustration

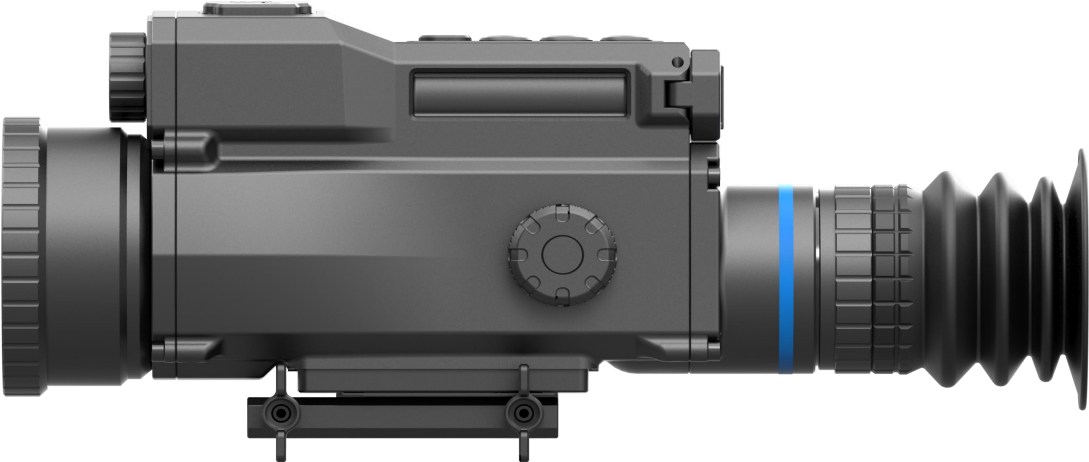



5.Product Usage



- (1) Install your battery first.
- (2) Press the <Power> key for 3 seconds to start observing objects through the eyepiece.
- (3) To turn off, press the <Power> key for 3 seconds.
- (4) After switch-on, the camera system will automatically choose the most suitable start-up among White-Light, Fusion, Low-Light and Thermal Imaging mode according to environmental illumination.
- (5) Rotate the eyepiece to adjust the view until the cursor on the screen is the clearest.
- (6) In Low-Light and Thermal Imaging mode, press the focusing knob until the object is perfectly focused. In Fusion mode, adjust the focus well in Low-Light and Thermal Imaging mode.
- (7) Rotate the screw encoder button (menu-off) to adjust the digital magnification(1.0X, 2.0X).
- (8) Short press the <MODE> button to switch the camera mode. The images observed in the eyepiece will appear in the following order: White-Light, Fusion, Low-Light and Thermal Imaging.
- (9) Short press the <Photo&Video> button to turn on the <Photo> function. Long press the <Photo&Video> button to turn on the <Video> function. Long press this button again to turn off the <Video> function.
- (10) Short press the <Menu> knob, the Menu icon will appear on the screen. Rotate the <Menu Knob> to select the function, then short press the <Menu> knob to confirm.

6.Menu Interface

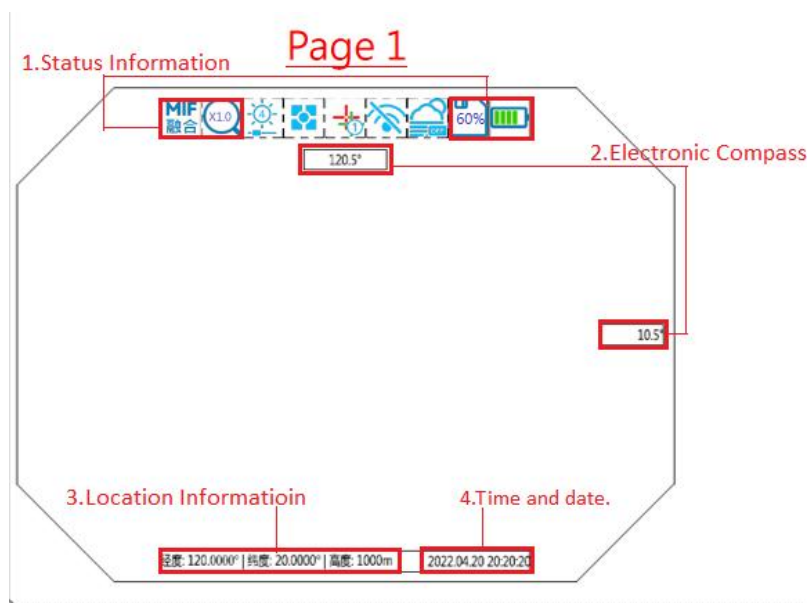

• Status Information:(As Shown Above)

1. Status Information : Mode, Magnification, Remaining Memory Capacity, Remaining Battery Life.
2. Electronic compass, Azimuth, Pitch Angle.

3. Location Information: Location and Altitude Information.
4. Time and date.

• OSD illustrate:

A) In page1 the status bar is located at the upper part of the display screen, displaying the actual operation status information of the sight, from left to right:

1. Display Brightness
2. Metering Mode
3. Cross Hair
4. WIFI

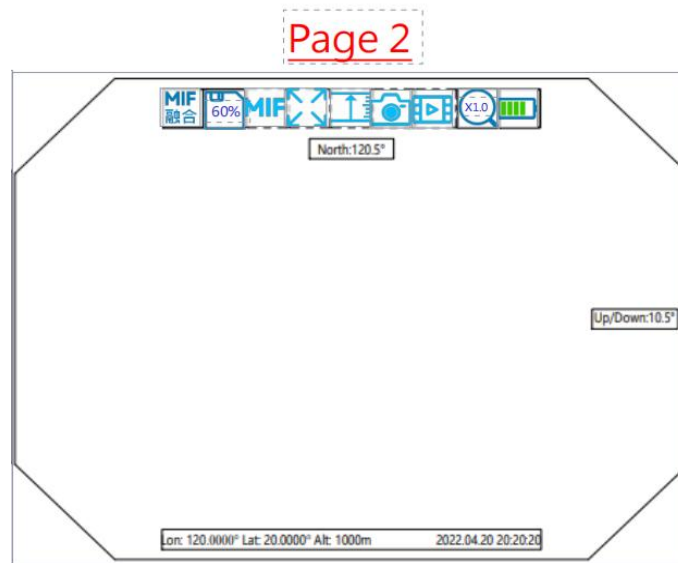

B) In page2 the status bar is located in the upper portion of the screen, displays information about the actual operation state of the sight, from left to right in turn as follows:

1. Display Mode
2. Digital Zoom
3. Laser Ranging
4. Take Pictures
5. Video Recording

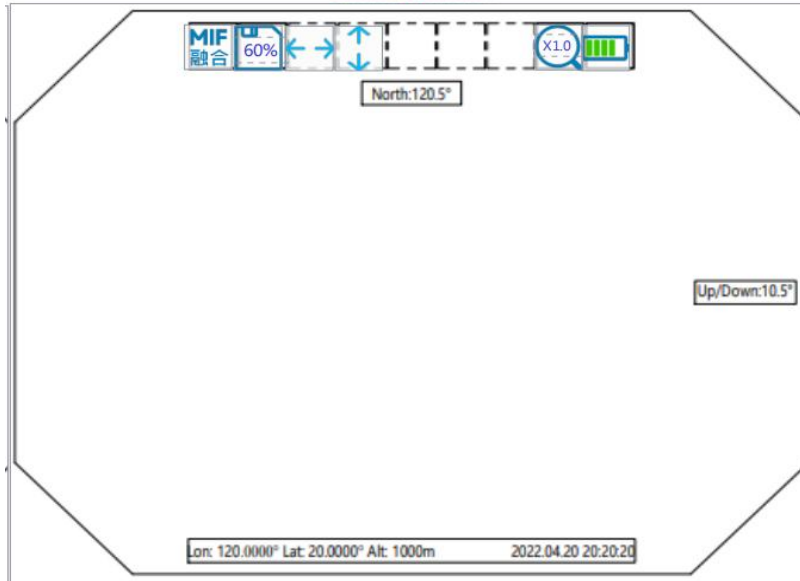



C) In page3the status bar is located in the upper portion of the screen, displays information about the actual operation state of the sight, from left to right in turn as follows:

1. Crosshair Horizontal Position Adjust
2. Crosshair Vertical Position Adjust









7.Operation Description

Default instructions:

- Press the menu knob to access the main menu
- Rotate the menu wheel to select the desired menu item
- Tap to access the menu item
- Rotate to select the required gear, short press to determine

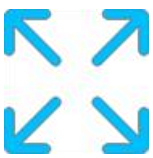
Item	Icon	Designation	Number of Gears	Illustrate
1		Display brightness	6	Brightness control <ul style="list-style-type: none"> • The brightness level is between 1 and 6, Higher level means higher display brightness • Default : 4
2		Metering Mode	2	Metering Mode <ul style="list-style-type: none"> • Average Metering Mode Default mode. Evaluate whole frame and make it to be at best exposure status. • Spot Metering Mode: Only evaluate small part around cross hair, ignore

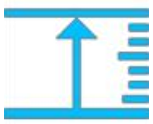
SHINENYX

				the rest of frame.
3		Cross Hair	6	Cross Hair(Off ,Color) <ul style="list-style-type: none"> • Cross hair can be hided or change color. • Default: 1
4		WIFI	2	WIFI (On/Off) <ul style="list-style-type: none"> • This function permits transmission of Video from telescope to external equipments via WIFI. • Default: On
5		Camera Mode	5	Camera Mode <p>• 5 Modes:  微光、 热像、</p> <p>MIF1 MIF2 MIF3</p> <p>Low-light, Thermal Imaging, MIF 1 Mode , MIF 2 Mode, and MIF 3 Mode.</p> <ul style="list-style-type: none"> • Use <Mode> button to switch the mode.
6		Digital Zoom	3*	Digital Zomm(1.0X . 2.0X and 4.0X) <ul style="list-style-type: none"> • Rotate left side knob to switch(when menu-off), or click button as usual • Default: 1.0X
7		Take Pictures	1	Take Pictures <ul style="list-style-type: none"> • Tap the button to shoot a photo. • Use <Photo&Video> button, short press to shoot a photo.
8		Video Recording	2*	Video Recording <ul style="list-style-type: none"> • Tap the button to record a video. Tap again to stop recording. • Use photos & video button, long press on video; Long press again, stop video
9.		Laser Ranging	1	Laser Ranging <ul style="list-style-type: none"> • Tap the button to measure the distance,or use the <LR> button to measure the distance. • Target location should be displayed when the electronic compass is turned on.
10		Crosshair Horizontal Position Adjust	1999	Crosshair Horizontal Position Adjust <ul style="list-style-type: none"> • Default: 000
11		Crosshair Vertical Position Adjust	1999	Crosshair Vertical Position Adjust <ul style="list-style-type: none"> • Default: 000

8.Precautions

- When the operating environment of the equipment changes from low temperature to high temperature, it is necessary to heat the equipment first. Otherwise, the use of the equipment will be affected, because there may be water mist on the lens.
- When used in temperature below -40°C , the battery needs to be placed in a warm place (such as a chest pocket) before the device is turned on.
- Only approved accessories and battery accessories should be used, rather than using incompatible products.
- It is recommended to use a good quality 18650 battery, because the use of inferior batteries will not only affect the use effect, but also easy to damage the equipment
- Contact with rain or fog, falling, bumping, and other behaviors will damage the equipment.
- It is not recommended to clean your lens frequently. Lens paper or cloth can be used when wiping.
- To prevent battery damage, the battery should be removed, when the device is not used for more than two weeks.
- To avoid moisture exposure to the lens, the device should be placed in a dry, ventilated place.
- Personnel who install or repair moldy equipment need certain qualifications.
- In order to avoid injury to the human eye or damage to the rangefinder, it is necessary to pay attention to the operation specification when using the rangefinder

9.Packaging and Accessories

- 1 scope With Dual-waveband Fusion Telescope scope
- 2 x 18650 batteries
- 1 piece of mirror wipe
- 1 USB cable